

Acoustic Configurations Technology in Future Architecture

Alireza Einifar ^a, Farbod Abed^{b*}

^a Associate Professor in University College of Fine arts University of Tehran, Ph.D. in the same field from University of New South Wales, Sydney, Australia

^b Master of Architecture, Tehran University, Kish International Campus, Tehran, Iran.

Abstract

The present architecture is more ever relied on components by contribution of modern architectural technology provided comprehensive outcomes both directly and indirectly, it is evident that there is interactional architecture as a new fashion by reviewing related backgrounds, the strategy ascribed to the present paper focused on quasi laboratory prototype based simulation and modelling to devise a latest technology with an aim of creating prototype out of interactional architecture, the present study embarks on novel atmosphere for interaction between man and environment by operation of acoustic tube finally to create a novel fade rests on interactional architecture since acoustic tube provides significant function in manipulation of efficient configuration out of interactional architecture.

Keyword: Architectural technology; Modelling; Interactional architecture; Acoustic tubes.

1. Introduction

Architecture appeared as the principal information reference historically it serves culture, religion and policy, while that field faced with different movements of artistic, cultural and religious trends, Arts were prone to a lot of changes streamlined with other fields following industrial revolution, architecture exposed to technology similar to different fields of arts, therefore it adapts with that course even it surpasses it strongly, like greenhouse architecture which it provides automatically energy demand and offer process, nomenclature of technology in the modern architecture means innovation and creativity in architecture and technical design which are admirable and unprecedented. Architecture doped with innovation, creativity and engineering is spite of artistic work and design aspects due to recognition and conception of construction behaviours toward forces.

* Corresponding author. Tel.:+98-937-8506499 ; fax: +98-21-8825-3709
E-mail address: farbod_abed@yahoo.com

Introduction of modern technology to realms whose enriched identity and history encountered with technological attitudes in the background of arts and architecture generates challenges whether major communities like Iran are devoid of required embedment as substructure in facing of globalization trends. Architectural technology is combination of soft and hardware as by product in marketing, hence it could adept and transform the products.

2. Acoustics & Architecture

Acoustics composes of sound production ,transmission and receiving in two forms directly and indirectly, direct sound transmitted in spherical form it perceptible by audience directly, thus it transmittable instantly in all directions but whenever sound collided with a plane it may reflect and receivable by audience, sounds concurrently transmitted in different directions and receivable at the same time.[1]

Acoustic control means transmission control directly and indirectly (secondary directions) by sound, there are three notions for versatile sound in the environment: Firstly fidelity sound control and receivable by man directly, the element composes of transmission and resonance and diminishes the time of resonant time to withhold sound overlapping reciprocally, secondly prevention of noise which achievable through fitted site alternative stands far away from noise pollution, dual partition walls, absorbent materials and separation of the devices from those setting and placement of interfacial spaces like corridors and external inter setting accumulators including aural spaces and thirdly utilization of ideal acoustic systems, consequently the sound amplified by application of microphones, speakers and amplifiers and setting a control room which are variable according to the way of function therefore it plausible to use different systems.[1]

Music was indispensable part of primitive civilization and represented as format of communications among the men as indispensable part of community, therefore it not odds that the man has seeking a wonderful media to perform realistic music with span of million years, indeed sound fidelity perceptible bodily by man, meanwhile it functions incredible, concurrently its onset begins by conversation by men and succeeded to stage of aural music melodies , it is plausible to create a medium with noise pollutant proof by physical strategies, consequently the silent setting shall be plausible by suppression of redundant sounds known as setting isolating from unpleasant noises.

Bernhard Leitner is on of the few, and in this assumes an important role, who pursue connections which constantly interact and combine, in order to fill our spaces with simultaneous attraction of the architectural and sonorous. As an architect and composer of sound he knows that perception includes sound material, which one has to learn to master, and the dynamic lines which make us see and enter built space. Space and sound have no definite spans of time. They stand for a transitory situation without end and create a continuum. Bernhard Leitner shows us a space for seeing and hearing which we take in and changed. Even our breathing is part of this non-static architecture. His kinetic and architectural compositions reveal aspects of the world and constitute as defined spaces (receptacles for the body: Sound Space at the Technical University of Berlin, "Cylindre Sonore" in the Parc de la Villette) the potential for a new architecture which brings together the experience of the architect, the art of the composer and the determining will of the sculptor (fig. 2-1).[2]



Fig.2-1: Cylindre Sonore

Le CylindreSonore is embedded in a bamboo garden, a valley-like, sunken landscape in the Parisian Parc de la Villette. A Sound architecture commissioned and implemented as piece of public art, as intervention artistic, for the Section IV of the park. The upper end of the double cylinder is at the same level as the bordering allees. Coming from the park, one descends a long stairway into the sound space before actually entering the garden. On leaving it, one once again walks through the sound space before one ascends to the park situated on a higher level. The sound that can be heard from the outside attracts the passers-by, inviting them to stop and focus on the static and stationary form. A closed architecture, only covered by the open sky, intended as a conscious delimitation from the spacious park. A cylindrical space that allows a concentrated listening of the place, a contemplative rediscovery of oneself in transcendence of the place (fig. 2-2). [2]

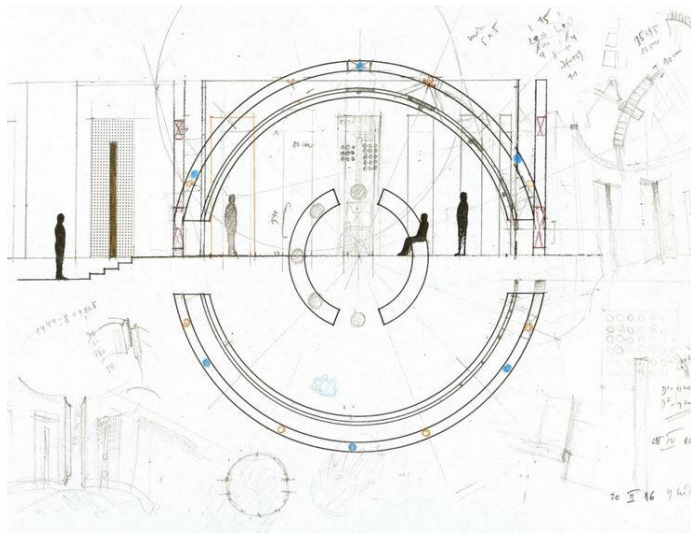

Fig. 2-2: Cylinder Sonore

The inner diameter of the double cylinder is 10m, the height 5m. Behind the eight perforated concrete elements three loudspeakers have been mounted vertically like a column. The circular space between the two curved walls is a functional space for the maintenance of the loudspeakers. It provides access to the control room under the ground. The ring is, however, first and foremost a resonance chamber, which consolidates the sound by means of weight and tension of the curved surfaces (fig. 2-3). [2]

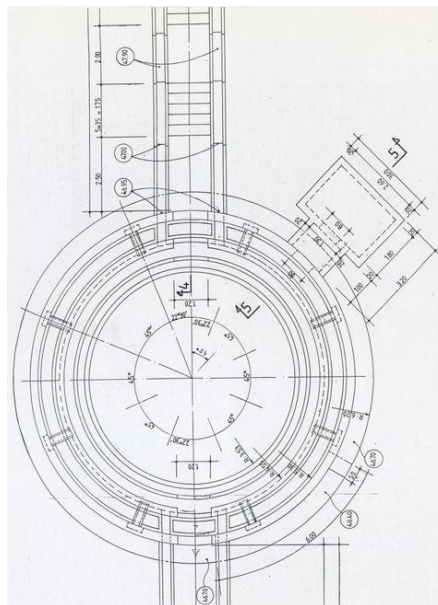

Fig.2-3: Plan of Cylindre Sonore

From each concrete element, water forms narrow rivulets into the basin which encloses the ground of the cylinder space like an island. The hushing sound distracts from the sounds of the urban environment, neutralizing the space. The rivulets acoustically tune the inner space. They are a prerequisite for the acoustic sensors and cells, ears, skin, the body and the brain being able to listen in a concentrated way (fig. 2-4).[2]

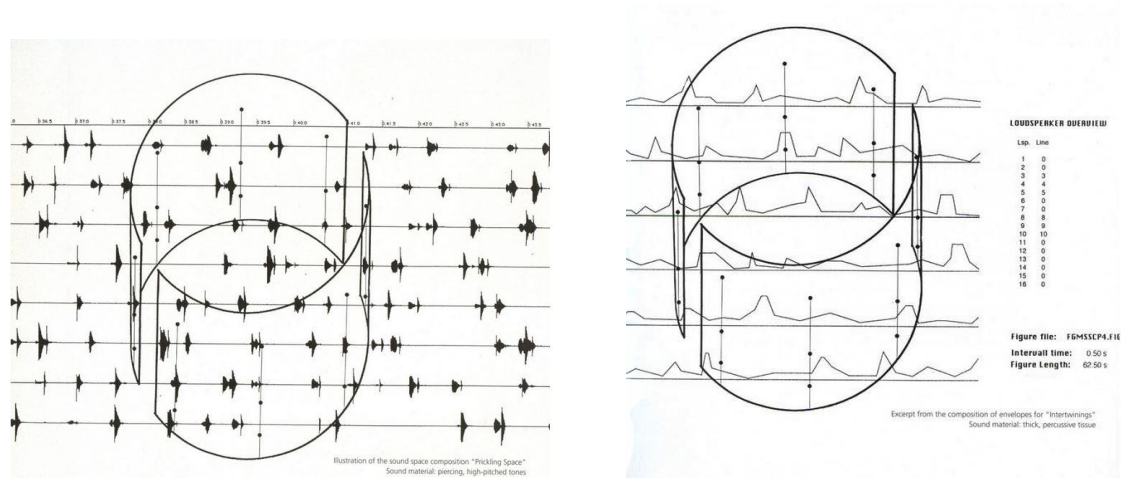

Fig.2-4: Sound Organization

Sound space are constructed, developed, varied in the Cylinder Sonore between the sound columns behind the eight perforated concrete elements, i.e., between 24 loudspeakers. These are temporal spaces. Statically drifting, room-filling sound-tissue; circular supporting sound lines tracing the shape of the architectural instrument; prickling, high-pitched sounds along the envelope walls contrast with the archaic static of the concrete cylinder. Massive, heavy or light, transparent spatial bracings; guitar tissue as static filler material; material with a delayed reverberation time softens the concretes.[2]

3. Interactional architecture

Medium design created a lot of assumptions over function of design in terms of social interaction, the discussed component is applicable in many designs of architecture, common words uttered by architects like: spatial archetypes established in order to be communicable by men for social contact, the underlying theory of those assumptions inferred as formation of moving passes and location of setting the common services in order to affect social contact among people.[3]

Open spaces or public and quasi public areas provide a place for assembly of community or it could be a place to dispel the community because, the designer fails to plan an atmosphere for assembly and appealing the people, Osmond holds it is false to assume that face to face communications to subdue the appearance of locals because it is necessary to create a prior atmosphere along desired interaction drifts, therefore the interactional places and

rendezvous should be pleasant areas for the community, whenever social requirements sense of independent fulfilled it is being streamlined with social relationship. Spaces which their private or public boundary subdued it creates less control over social relationship as a result it affect social interaction because physical privacy counted as prerequisite of social behaviours, whenever there is a physical privacy it shall bring about individual choice, if the social requirements joined with individual sense of independence, then social interactions shall be gained easily, the spaces blended with undefined boundary either privacy or public, consequently the results emerged under less control over social relationship and subdue social interactions.[3]

Should the community fond of social communications it is evident they shall provide required background to fulfil man requirements under affection of place for meeting and attractive feel to join each other, functions like interactions and watching the characters of others it creates the social backgrounds for assembly of people and nurture the individual maturity, Christopher Alexander (1992-77) held informal appointments to provide daily friendship and affection, architects, urban and environmental designers stress on creation of opportunities for private relations, whenever social and administrative systems support environments, it is possible to use effectively the predicted potentialities, otherwise it is contingent the public utilities abated, interactional architecture brings about novel philosophy and ideas in the field of architecture it may followed by other arts like Technology and information technology under unified strategy, the current paper pursues the element of simulation and modelling under quasi laboratory prototypes by allocated Technology which encourages underlying structure pursuant to interactional architecture.[3]

4. Fundamentals of Theory

Acoustics holds different definition, sound is a physical radiation under various pressures in elastic medium (air), acoustics engulfs the man interacts with it in the vicinity, man typically discerns the voice in the ranges from 20 to 20000 Hz, thus sound composes of successive pressure changes, enhance the pressure changes expose to compression and expansion in the air, refer to (fig. 4-1). [7]

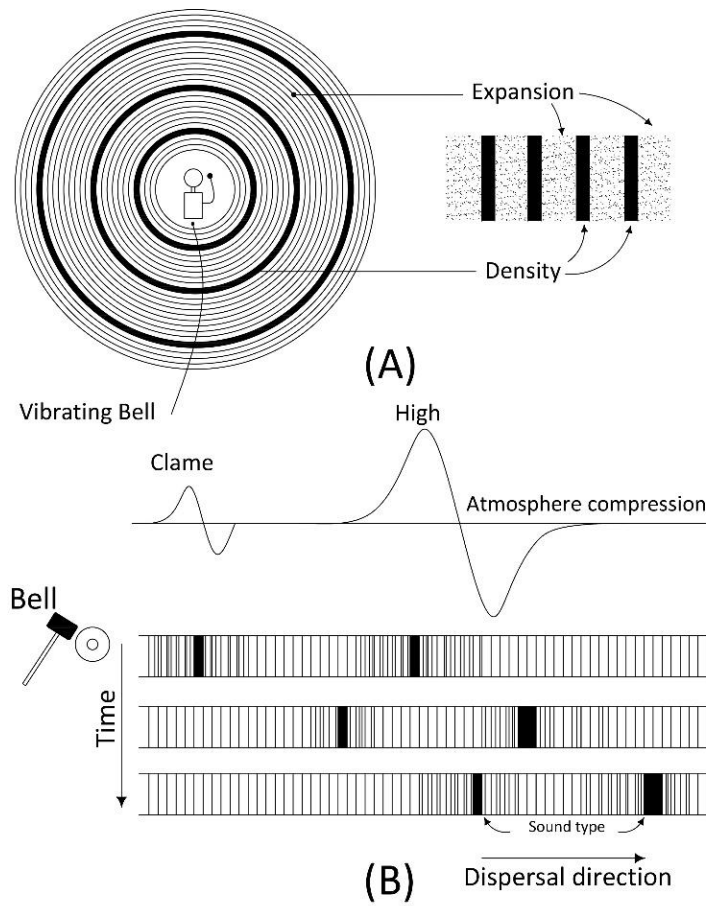

Fig. 4-1: sound pressure waves (A), sustained vibration gained from vibrant ring (B), there are two types of different range dispersed from the source.

Ring sound is a pure tone which radiated in all directions uniformly under generation of circular waves, the same vibration radiated with identical frequency following vibration of ring which carrying lengthwise sound intelligent ,therefore sound means mechanical lengthwise wave radiation but a pure tone is available scarcely. Music comprises of cardinal, square & integral number with main frequencies (fig. 4-2). [7]

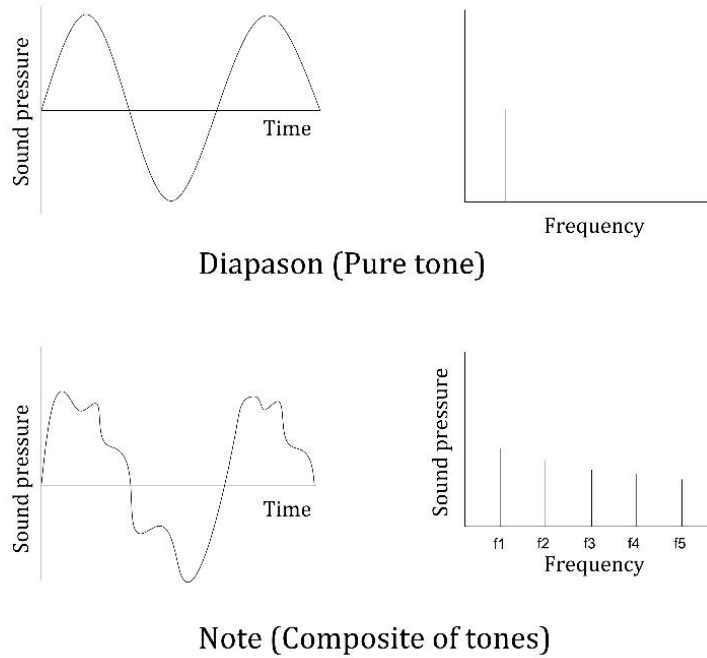

Fig. 4-2: Schematic diagram of pure tone and music note depicts sound pressure changes against time and frequency

Sound travels with different speeds according to the nature of medium for propagation. Sound speed travel in the air and field elevation stands 344 m/s. Sound source with invariable power (watt) in the free space propagates the sound waves far from resonant surfaces (fig. 4-3). [7]

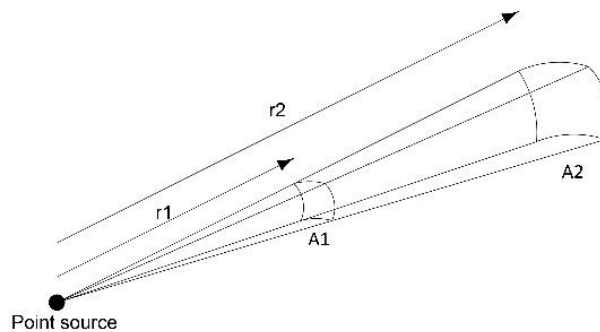

Fig. 4-3: Total energy passes from A1 to A2 uniform, whereas A is proportion to r , then energy density or intensity is proportion inversely to r^2 .

I: sound intensity with scale of W/m^2 or W/m^2

$$I = \frac{P}{A}$$

P = Sound source power in watt scale.

A = area in scale of m^2 or cm^2

Whereas, sound propagated in all direction, then:

$$I = \frac{P}{4\pi r^2} \text{ w / cm}^2$$

r held as radial of virtual sphere

Intensities I1 & I2 for distances r1 & r2 calculated by contribution of point source as follows:

$$\frac{I1}{I2} = \frac{r2^2}{r1^2}$$

The above equation depicts that the sound intensity diminishes inversely distance square from the source. The discussed lab model provides a design to fulfill quite fidelity sound environmentally by attributed air flow with envisage of sound characteristics in order to improve the quality of medium for purpose of applying sound tubes to control the nuisance of wind flow on one hand and to create fine sound fidelity on the other hand in the vicinity. The arranged studies pursued as prerequisite to provide lab prototype according to the proposed configuration usable in effective productivity and quality upgrading. [7]

5. Examining the Samples

Initially it is necessary to draw a diagram to define challenges and advantages ascribing to lab prototype by making a versatile model.

Primarily the required configuration created for interaction drifts, the main point in calculation of those components is absence of social interaction in the vacant space which resulted in empty of location for any functions, then persisting on empty space focused on resolving the challenges.

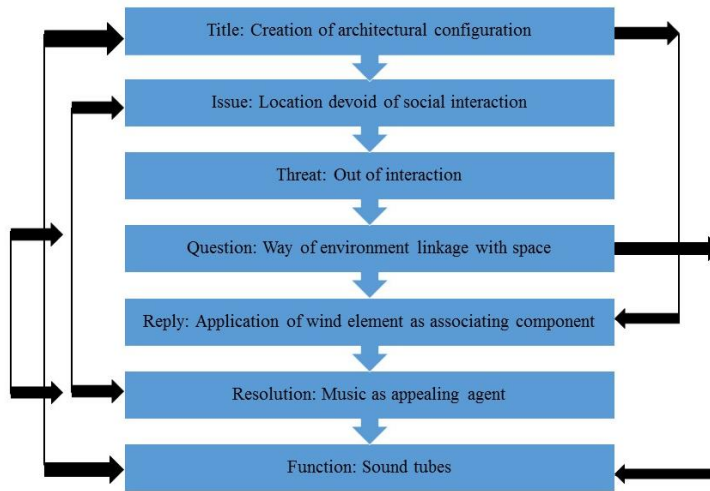

Table 1-1 Relationship diagrams.

Prototype sample proved by function of flute and wind blowing by performer, the performers creates different note by blowing & blocking air vents in the flute (fig. 5-1). In the present model, the performer is wind as west dominant which required music produced by operation of intensity and blowing (fig. 5-2).

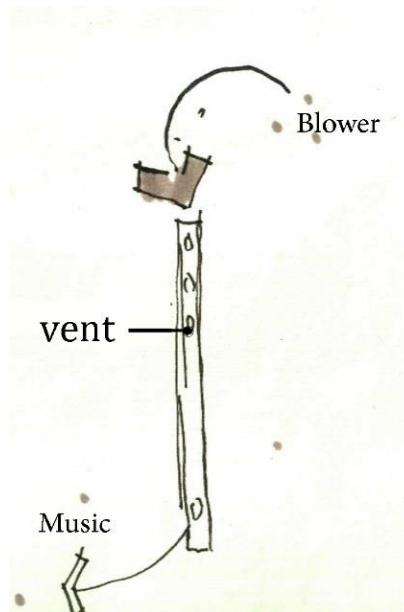

Fig. 5-1: Flute system and its function

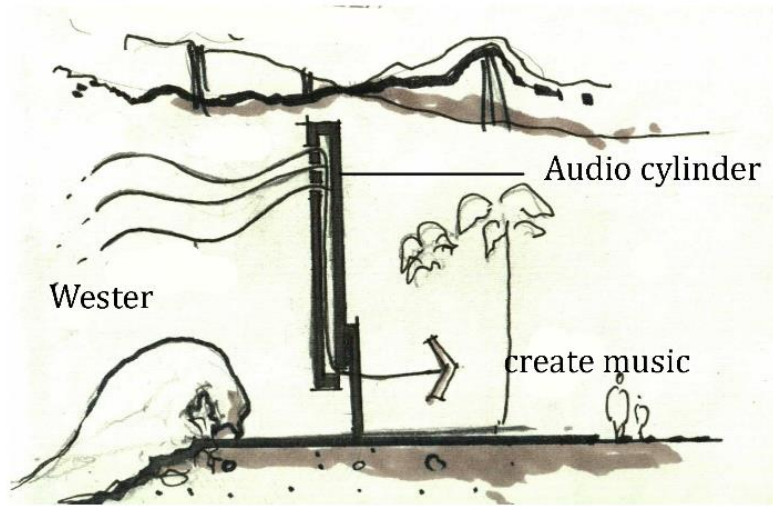

Fig. 5-2: sound tube & its operation

Following completion experiment and calculation of primary model efficiency the relevant elements produce required music by putting to gather the sound tubes according to the different vents for air outlet refer to fig. 7-1 as a result wind blown in the sound tubes consequently different harmony and melody formed through each tube, therefore the delightful music being created by combination of those melodies (fig. 5-3).

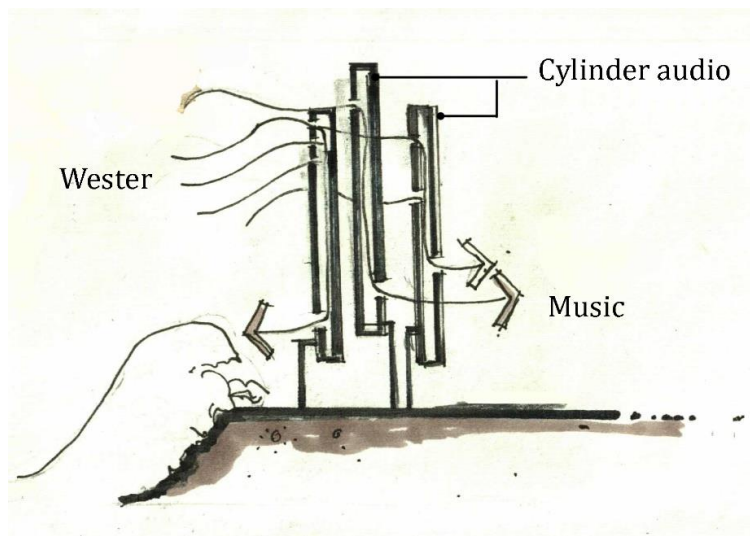

Fig. 5-3: Combination of sound tubes for creation of music

Following assembly of those sound tubes and performance of experiment the model demonstrates its efficiency, the discussed model attracts the men in one point, originally the architecture encourage the people to join each other for interaction, while various music sets and melodies created due to different of yearly months (fig. 5-4).

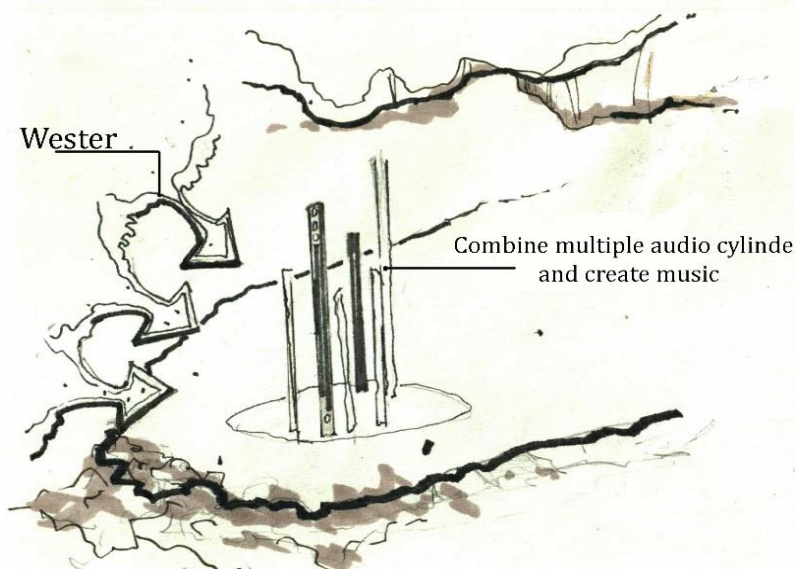

Fig. 5-4: Configuration and functions of sound tubes in the medium

6. Conclusion

The proposal model is applicable as an architectural works for prosperity of prospective norms according to the configuration made by the current paper and by studying the lab prototype model since the present model assembles medium elements with contribution of architectural technology in order to create interaction between architecture and medium so that to encourage the men come to gather as an opportunity to reinforce it for social and individual interactions. Sound tubes counted as creative and novel design so as to transform the essence of architecture beyond the ordinary place and aesthetic fad by link it to medium elements like wind as a manifestation of architectural and aesthetic component for wonderful usage and tool.

References

- [1] Ghiabaklo Z. Fundamentals of Building Physics 1, Acoustic. Tehran: Jahad Daneshgahi Elm va Sanat; 2011.
- [2] Arch daily, AD Classics: Le Cylindre Sonore / Bernhard Leitner. <http://www.archdaily.com/168152/ad-classics-le-cylindre-sonore-bernhard-leitner/>; 2011.
- [3] Lang J. Creating Architectural Theory. Translated by Alireza Einifar. Tehran: Tehran University; 2010.
- [4] Mahdavinejad M J., Refalian GH. Algorithmic Architecture. Tehran: tehran azad university science and research branch

2013.

- [5] Ghiasvand H. Continuation Language in Architecture. Civil Engineering Seasonal Periodical: 2009, (60):68-73.
- [6] Lechner N. Heating, cooling, lighting: Design methods for architects, Translated by Keynejad MA., Azari R. Tabriz: Tabriz Islamic Art university: 2005.
- [7] Stein B., Reynolds J. Mechanical and Electrical Equipment for Buildings, Translated by Nasiri P. Tehran: Building and Housing Research Center: 2010.
- [8] Bullivant L. 4dspace: Interactive Architecture. London: Wiley Academy, Architectural Design: 2005, 30-37.
- [9] Watson D. Architecture, Technology, and Environment. Taylor & Francis: 2014, 119-126.
- [10] Terzidis K. Algorithmic Architecture. England, Oxford, Elsevier: 2006, (3): 65-103.