

Thermal Performance of Earth-Sheltered Residential Buildings: a Case Study of Yazd

Nazanin Nasrollahi^{a*}, Fatemeh Akrami Abarghuie^b

^a Assistant Professor, Architecture Department, Engineering Faculty, Ilam University, Ilam, Iran

^b M.A. of Energy in Architecture, Architecture Department, Engineering Faculty, Ilam University, Ilam, Iran

Abstract

Soil is among the cheapest and most available materials found in the human living environment. Seeking refuge in the heart of earth and benefitting from soil's thermal property, based on experience, is a strategy employed in the past across some regions. Also the passive systems are amongst the cheapest methods of providing heating and cooling demands of the buildings. These systems experience the lowest impact of environmental degradation while increasing the energy efficiency of the building through decreasing heat gain and loss. The idea of the earth-sheltered buildings is amongst the passive construction that has been embraced by the architects. An earth-sheltered building, as a passive idea, can guarantee, extensively, the reduction of energy consumption and provides the required conditions for thermal comfort. The present study discusses and investigates the thermal performance of earth-sheltered residential buildings in Yazd city of Iran. To predict this type of constructional thermal behavior, subsequent to field and library studies, thermal simulation was employed using Energy Plus software. Energy Plus software is able to simulate the envelopes adjacent to soil. The simulation process is conducted through depth changing of the soil surrounding the sample, assuming its thermal properties are constant. Considering the results, by increasing the depth of sheltering in amount of soil, its energy consumption saving will increase. In this situation annual temperature fluctuation decreases 50% and it saves about 67% of energy consumption. In addition the most hours set on thermal comfort zone. This subject adds 50 more days to annual Earth-Sheltered acceptable thermal comfort conditions. Moreover due to investigating of the building orientation as an effective element for energy consumption, south orientation is specified as the best position for energy reduction in Earth-Sheltered.

Keywords: Earth-Sheltered, energy consumption, thermal comfort, temperature modification, Underground depth

1. Introduction

Lack of harmony between a construction and the climate in which it is located, on one hand, and on the other hand, forgetting past experiences, have caused numerous damages, one of which is increased energy consumption. This has given way to the recent proposal of construction of passive buildings. Soil is among the cheapest and most available materials found in the human living environment. Seeking refuge in the earth's crust and benefitting from soil's thermal property, based on experience, is a strategy employed in

the past across some regions. Earth-sheltered buildings are among passive constructions which have been welcomed by architects [1]. An earth-sheltered building is, in fact, referred to a building which is buried, to a certain depth, in the ground. As a result, instead of air, some parts of the building will adjoin earth, and thus, benefit from its thermal properties [2]. Evidence shows that seeking refuge in the ground is one of the oldest constructional and architectural technologies [3, 4]. There are countless examples of this type of construction in Asian countries including Iran and Kuwait. One of the first attempts for introducing general properties of earth-sheltered buildings, especially in architecture, was undertaken by Carmody and Sterling, who have discussed them from different aspects [5, 6]. Other researchers developed guidelines for the evaluation of feasibility studies for the construction of earth-sheltered in hot and dry climates in the years that followed. They discussed requirements and advantages and disadvantages of these buildings, and introduced general strategies for residential buildings [7, 8]. Since soil's thermal performance is the most important reason for encouraging the adoption of earth-sheltered spaces, as per public experience, the foremost incentive for using it is reducing energy consumption. In fact, lower connection of earth-sheltered buildings, reduces heat loss and gain through the envelopes, and as a result, the peak heating and cooling loads of the building decline [9]. Besides all the above, due to soil's high thermal inertia, the penetration of heat transfer into the earth-sheltered building is delayed, accordingly, the offered energy saving is higher compared to buildings built aboveground [10, 11].

The mentioned studies are mostly qualitative, merely describing distinct features of earth-sheltered buildings from an experimental point of view. However, proving the thermal advantages of this notion requires practical and more serious examinations. To do this, researchers have employed thermal simulations. One of the first simulation studies was conducted in New Delhi, India, for investigating five different types of earth-sheltered buildings, showing that thermal performance had direct association with the burial depth and that the most heat loss in such buildings occurs through the corners, which were advised to be insulated [12]. Also, the study by Anselm on heat storage performance of earth-sheltered buildings, with an atrium, in hot and dry regions, concludes that 5-meter deep buildings experience 11 degrees lower temperature in the summer [13]. Yet, the building's energy consumption is not compared to its aboveground peers, adjacent to free air. The need to analyze the difference between thermal performance of earth-sheltered buildings and common aboveground ones has shifted recent studies into this direction. Works of Al-Nimah on using insulation, as well as Chris Van Dronkelaar on the different functionalities across different climates were all based on the comparison of earth-sheltered and aboveground buildings [14, 15].

Another feature associated with the thermal status of earth-sheltered buildings is their thermal stability as compared to outdoor. Hence, using earth-sheltered buildings for foodstuff preservation can be employed by many industries. Thermal properties of underground cellars lead to a 70% reduction in annual air temperature fluctuations, creating a desirable environment for storing foodstuff [16, 17]. Temperature stability of such cellars, in spring and summer is much higher than that of outside, while, this stability declines in fall and winter as a result of the rising wind and ventilation [18]. The majority of studies carried out on thermal performance of earth-sheltered buildings are concerned with the relationship between type and depth of soil and the thermal status inside the building. Yet, the influence of other contributing factors on thermal performance of such buildings, including light, ventilation, and orientation, has not been specifically addressed. The present study investigates thermal performance of earth-sheltered residential buildings in the hot and dry climate of Yazd, from different aspects. Due to the fact that openings give way to heat exchange, ventilation, and sunlight, it seems essential to investigate thermal performance of earth-sheltered buildings in terms of the different orientations they possess. Therefore, study of thermal response of earth-sheltered buildings, considering the climatic conditions of Yazd, also needs to take into account orientation as a determining factor. The results of this study will be an important guideline in the area of design, construction, and improvement of these passive buildings.

2. Methods

2.1. Climatic Analysis

Yazd is located on the Central Iranian Plateau, at latitude $31^{\circ} 52'$ and longitude $54^{\circ} 16' E$ [19]. According to Köppen climate classification, it is located in a hot and dry region. . Due to the relatively low humidity in Yazd, there is a large temperature difference across different months, as well as, between day and night. So this city has long been trying to cope with environmental challenges and climate hardships, as it is located in a hot and dry region. Accordingly, this city has adopted a climate-compatible lifestyle, using different techniques and strategies. Among the features of traditional architecture in Yazd is the application of materials with high thermal capacity. Building mud brick housing has been one of the methods of compliance with the harsh environment of the desert in this region. One concept used in this city's architecture is the employment of soil's thermal capacity. Taking refuge in the heart of earth is a common technique used in different types of constructions in Yazd. Benefitting from sunken courtyards, cellars, and reservoirs scattered across the city are all evidence of the compatibility of earth-sheltered buildings with the regional climate and ecology, as well as, the culture of its inhabitants.

2.2. Sample Modelling

To be able to compare thermal performance of earth-sheltered buildings and other popular aboveground buildings, the very same model is required to be simulated both aboveground and adjacent to the earth's crust, and then compared. So we must assume a simple model with stable geometrical variation that has enough ability for underground simulation. In fact with complicated architectural model, underground simulation cannot answer the effect of main element that lead Earth-Sheltered thermal performance correctly. As a result, Best Case 900 ASHRAE, as per ASHARE standard, is proposed as the universal identical sample for high-mass buildings Earth-Sheltered. This is, a small sample to judge different thermal simulations using an identical model [20]. Simulating with this model can clear thermal behavior exchange between ground and building. Another determining factor is the envelope's adjacency and internal gain, proportional to building functionalities. According to Best Case 900 ASHRAE, only one of the facades holds two transparent openings (Fig. 1). Therefore, save for the light passing facade, which is adjacent to air, the others come into contact with earth. Other physical and functional properties of the present study are defined for the simulator as per Tables 1 and 2.

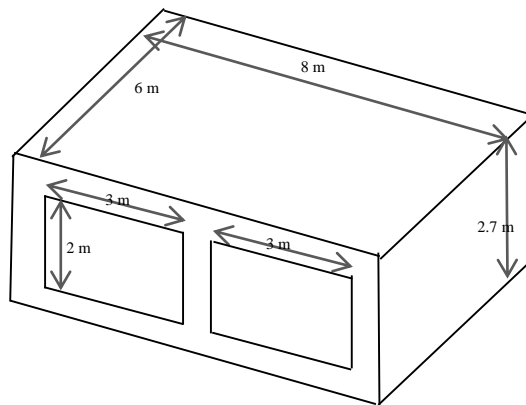

Fig. 1. Proposed Model for Research on High-Mass Building by Best Case 900 ASHRAE [20]

The prediction of thermal performance of earth-sheltered buildings through simulation is slightly different from other buildings. That is why selecting appropriate software with proper capabilities for soil simulation is of utmost importance. This study used Energy Plus software, capable of simulating envelopes adjacent to soil. However, owing to different thermal performance of soil, the simulation manner of a soil-adjacent building is dissimilar to aboveground buildings, thus, requires an appropriate method to offer soil's properties for the building in the simulation process. Experimenting with various methods, recent studies have addressed the appropriate method for the simulation of earth-sheltered buildings, using Energy Plus [17, 21].

Table 1: physical and functional properties of model

Element	Unit	Value
Occupancy	(m ² /person)	12
Area	(m ²)	48
Height	(m)	2.7
Internal Gain	(W/m ²)	4.16
Ventilation Rate	(ACH)	0.5
Heating and Cooling Set point	(C)	21-28

Table 2- Materials of Best Case 900 ASHRAE

Elements	Material	Conductivity Coefficient (W/m-K)	Thickness (m)	Density (kg/m ³)
Wall	Reinforced Concrete	2.15	0.25	1400
	Plaster	0.16	0.02	
Floor and Roof	Concrete Slab	2.15	0.2	1400
Double Glasses Window	Glass	1.06	0.00317	
	Air		0.013	
soil*		1.5		1925

* According to soil of Researched Region

Employing Best Case 900 ASHRAE, and having determined the constant conditions of the soil embracing the building, the soil environment around the building can be defined for Energy Plus, followed by the accurate analysis of heat transfer. The simulation is conducted through changing the depth of the soil surrounding the sample, with the assumption that its thermal properties remain constant. Then, while increasing the depth gradually, the thermal conditions of the building are examined in 0.5-meter steps (Fig.

2).

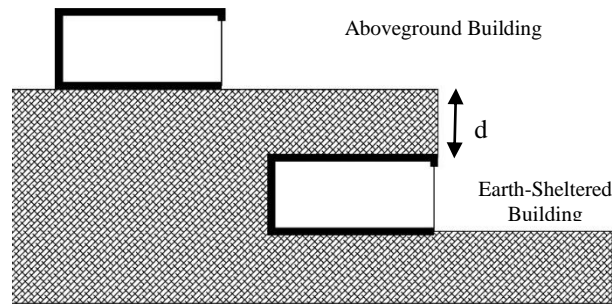

Fig. 2. Situations of models in Different Depth during Simulation Procedure
 d (m) = 0.5 , 1 , 1.5 , 2 , 2.5 , 3

2-3- Study of Soil Condition

Temperature fluctuates during the year, and such fluctuations vary in the different earth layers. Temperature fluctuation pattern of the earth is almost similar to the annual air temperature fluctuation pattern, which vary with each climate. The heat transfer through the soil is fundamentally different, compared with the surrounding air. Equation 1 gives the temperature of the earth surrounding an earth-sheltered for various depths and different days of the year [22]. This equation gives the soil temperature taking into account the specific thermal diffusivity properties of each soil with respect to the temperature of the region concerned. Calculation of soil temperature according to the climatic characteristics of Yazd provides the input data for the simulation (Table 3).

$$T(d, t) = T_m - A_s e^{-d\sqrt{\frac{\pi}{365\alpha}}} \cos\left\{2\pi/365\left\{t - t_0 - \frac{d}{2} \sqrt{\frac{365}{\pi\alpha}}\right\}\right\} \quad (1)$$

Table 3. Effective elements for Soil Temperature Calculation according to Climatic Condition

Element	Unit	Value
t_m	(°C)	19.1
t_0		3
A_s		13.5
α	(m ² /day)	0.0036

3. Data Analyze

3.1. Study of Effect of Orientation

The building surrounding by a huge mass of soil shows a different thermal behavior, compared to a building surrounded by the air. In addition to factors commonly used in study of thermal conduction of the contemporary above buildings, there are other more important factors to be considered when it comes to

earth-sheltered buildings. Since openings and transparent elements enable heat exchange, ventilation and light entrance, orientation of an earth-sheltered is a concern only when openings adjoin the surrounding air. Which side of the building has opening and transparent elements totally depends on the climate and function of building. Khair-El-Din proposed covering of the sun-oriented facade with the soil in the buildings located in hot and arid climates [11].

Different orientations of a building with respect to the sun, result in different thermal manner in different days of the year. Because Iran is located in the northern hemisphere, the southern facade is always exposed to the sunlight. To study the behavior of earth-sheltered buildings with different orientations, physical condition of the model must be considered to be fixed. Based on the premise of the research that the width of model is fixed, and every five sides are adjacent to the earth, the side with opening accessed environment air was oriented in the four cardinal directions. Thus, by changing orientation of the side with opening, the study model was studies in terms of thermal behavior in four orientations: eastward, westward, northward and southward. In thermal behavior simulation, the thermal behavior of the said model varied with its orientation. Figure 3 shows a comparison between the total energy consumption of the buildings for different orientations taking into account the depth of the building situation under the ground. According to this figure, when a building is placed above ground, the highest energy consumption related to westward orientation. After that eastward and northward orientations, have highest energy consumption respectively while the southward orientation provides the lowest energy consumption.

However, as the building goes downs into the earth, its thermal behavior changes. In this condition, northern orientation shows the highest energy consumption, followed by eastern and western orientations, while southern orientation has the lowest energy consumption. The only factor that remains unchanged in such buildings is that even when the Earth-Sheltered is oriented in the worst orientations, energy consumption decreases as the depth of building increases.

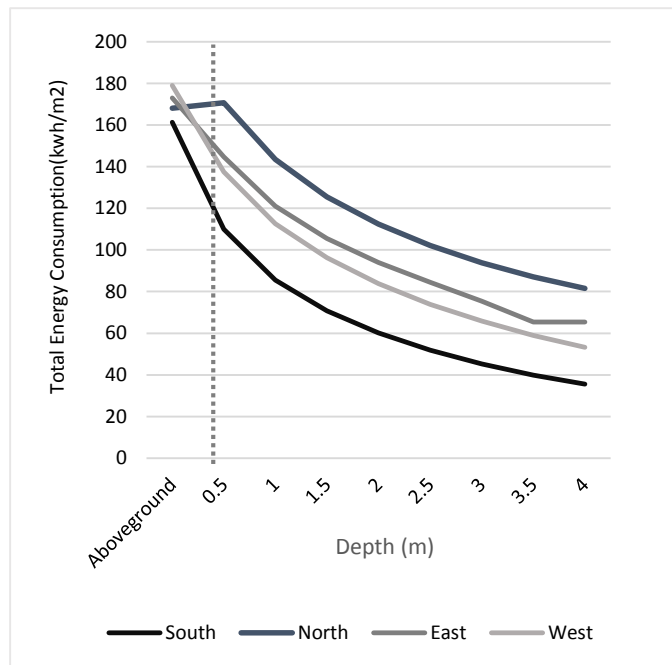

Fig. 3. Total Energy Consumption in different orientation

Another important conclusion is that as depth increases, the slope of energy consumption reduction almost reaches a fixed value (lower than 6 kwh/m²). The depth at which this phenomenon happens is different for different orientations. In other words, for each orientation, there is a specific optimal depth at which energy consumption reaches the optimal point. This value is 2.5 m for southward and eastward earth-sheltered structures, while it is 4 m and 3.5 m for northward and westward Earth-Sheltered, respectively. In this condition, total energy consumption of a residential earth-sheltered with depth of 2.5 m is reduced by about 67% (Fig. 4).

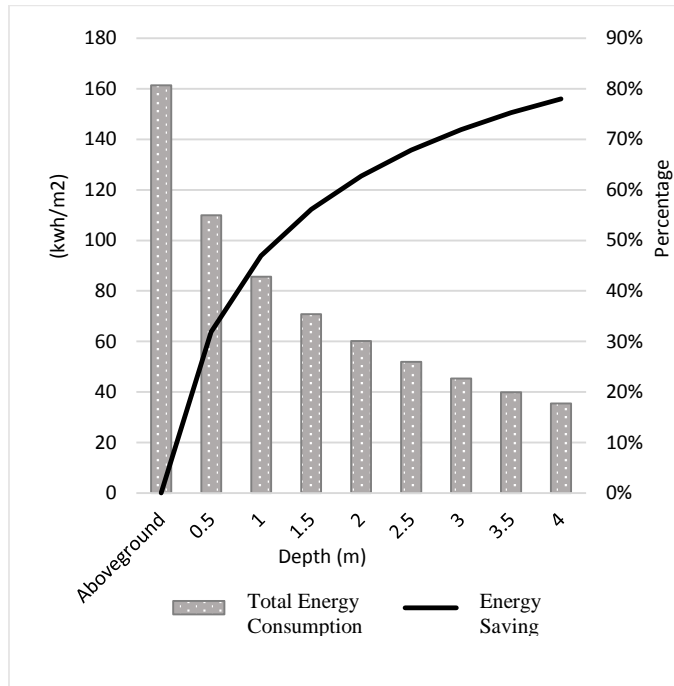

Fig. 4. Comparison of Temperature of Aboveground and Earth-Sheltered

3.2. Temperature Variations

As said, in the southward oriented earth-sheltered, energy consumption reduction varies at a very small rate as the building goes to depths lower than 2.5 m. Figure 5 provides a comparison between temperature of the interior space of conventional aboveground buildings and earth-sheltered that of southward oriented. As seen, maximum and minimum temperatures of aboveground building are larger compared with the open air temperature. However, as the depths of the earth-sheltered increases, thermal condition of the structure changes. According to these results, temperature fluctuation of the interior space of the earth-sheltered also decreases. In this condition, annual temperature fluctuation of the earth-sheltered structure is reduced by 50%, compared to the conventional aboveground building. Also, annual maximum and minimum temperature range significantly decreases in the earth-sheltered. In these building, temperature is reduced by 8° C in winter and 6.8° C and summer.

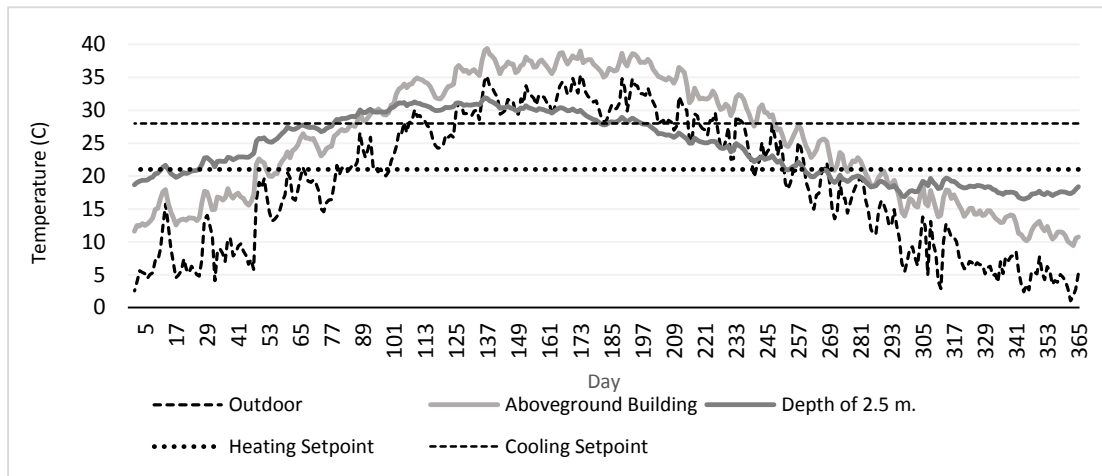

Fig. 5. Comparison of Temperature of Aboveground and Earth-Sheltered

3.3. Comfort Zone

In simulation of an earth-sheltered and a conventional aboveground building, temperature and humidity data of the interior spaces also showed a significant difference between these two samples in terms of thermal comfort. In Figure 6 and 7, data of these two building for the four season of the year is shown by the environmental output data on psychrometric chart.

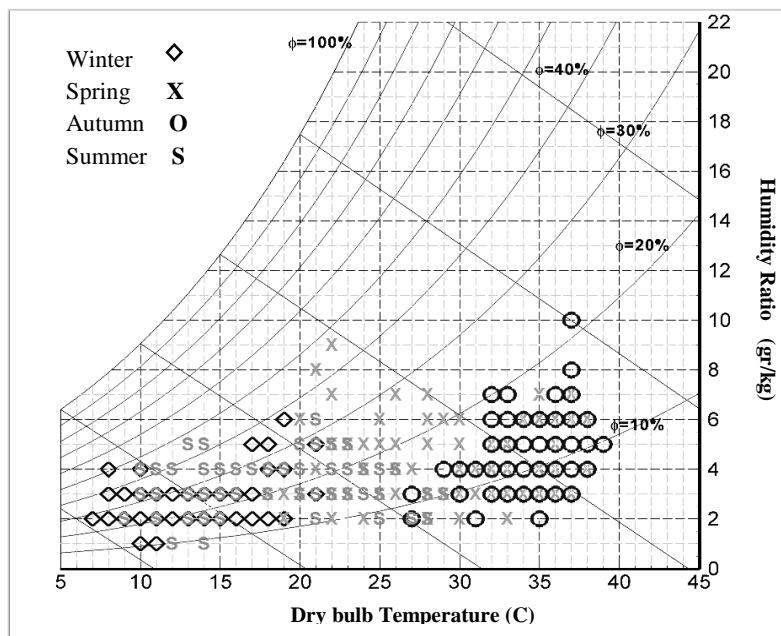

Fig. 6. Aboveground Building psychrometric chart

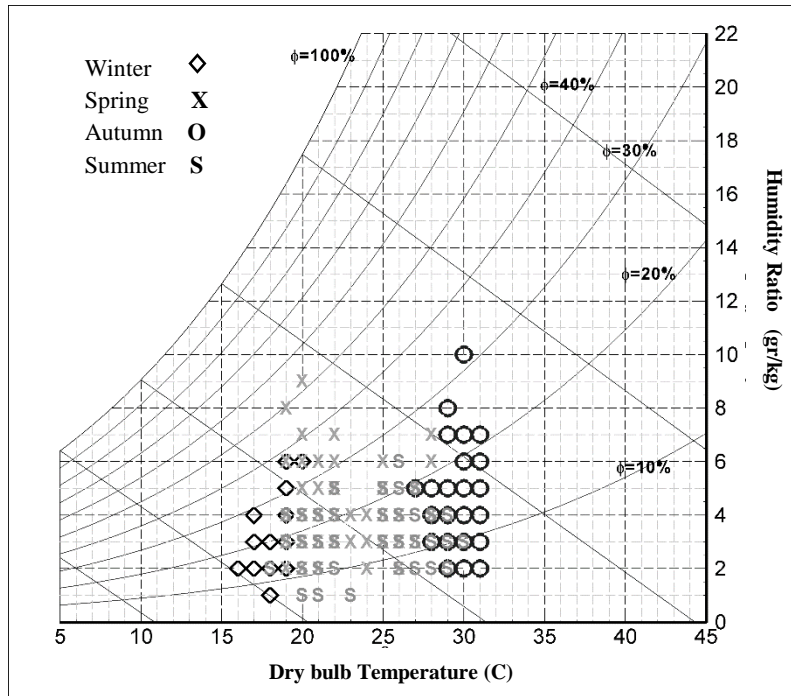

Fig. 7. Earth-Sheltered Building (in depth of 2.5 m) psychrometric chart

It is clearly seen from comparison of these two figures that thermal distribution of aboveground building is much higher than the earth-sheltered placed at 2.5 m depth (Fig. 6, 7). This causes a 50-day increase in comfort zone of the interior space of the earth-sheltered structure during the year. On the other hand, temperature and humidity condition of the above ground building is almost differentiated during the four seasons, while in the earth-sheltered, there is more overlapping between temperature and humidity range of different seasons as the season changes. Therefore, time lag of the earth-sheltered is increased, so that in the beginning of autumn and winter, the temperature range, and consequently the humidity range, still fall within those of autumn and summer, respectively.

4. Conclusion

In the study of the thermal performance of the earth-sheltered buildings and the effect of the important and effective factor of orientation on the residential function, southward orientation was found to provide the least energy consumption in all depths. Given the results, as the depth of the building increases, energy saving significantly improves, compared to conventional aboveground buildings. However, in southward orientation, difference between energy saving significantly reduces from depth of 2.5 m downwards. Under such circumstances, annual temperature of an earth-sheltered building is reduced by 50%, compared to conventional above ground building. Given indoor temperature fluctuation reduces as the depth of structure increases, a larger part of the year set in the comfort zone, enhancing the comfort zone by 50 days. Significant reduction of temperature fluctuation and increased thermal comfort zone in earth-sheltered

structures make such buildings a good option to deal with weather difficulties and climate change phenomenon. Based on the results, it is suggested that southward orientation be used for design of such residential earth-sheltered buildings. It is further suggested given the cost of increased excavation work not to consider the ceiling's earth cover depths of larger than 2.5 m.

This type of building with these characteristics can be a particular concept in the architectural community and also be an effective step towards the environment and energy efficiency. According to this result the next step for evaluating of Earth-Sheltered thermal performance should focus on architectural dimension like plan appropriation incorporating of ventilation and lighting as a variable parameter.

Nomenclature

$T(x,t)$	temperature of soil at depth d and on day t ($^{\circ}\text{C}$)
d	depth below surface (m)
t_m	mean annual ground surface temperature ($^{\circ}\text{C}$)
t	time of year from January (day)
t_0	day of minimum surface temperature (days)
A_s	amplitude of surface temperature wave ($^{\circ}\text{C}$)
α	the thermal diffusivity of the soil (m^2/day)

References

- [1] Benardos, I. Athanasiadis, N. Katsoulakos, Modern earth sheltered constructions: A paradigm of green engineering, *Tunnelling and Underground Space Technology*, 2014, (41) 46–52.
- [2] Givoni, B., *Climate Considerations in Building and Urban Design*, new York: van nostrand reinhold, 1997.
- [3] Al-Mumin, A., Suitability of sunken courtyards in the desert climate of Kuwait, *Energy and Buildings*, 2001, (33) 103- 111.
- [4] Al-Temeemi, A. Harris, D.J., A guideline for assessing the suitability of earth sheltered mass-housing in hot-arid climates, *Energy and Buildings*, 2004, (36) 251–260.
- [5] Bonan, G., *Ecological Climatology: Concepts and Applications*, Cambridge: Cambridge Press, 2002, pp. 32.
- [6] Carmody, J., Sterling, R., *Underground Space Design*, NewYork: van nostrand reinhold, 1993, 56-60.
- [7] Carmody, J., Olivier, H., Sterling, R., *Life safety in Large underground Building: Principles and Examples*, *Tunnelling and Underground Space Technology*, 1994 , (9) 19–29.
- [8] Al-Temeemi, A., Harris, D.J., The generation of subsurface temperature profiles for Kuwait, *Energy and Buildings*, 2001, (33) 837-841.
- [9] Golany, G., *Earth-Sheltered Habitat; History, Architecture & Urban Design*, , New York: Van Nostrand Reinhold, 1983, 64-140.
- [10] Jacovides, C.P., Mihalakakou, G., Santamouris, M., Lewis, J.O., On the ground temperature profile for passive cooling applications in buildings, *Solar Energy*, 1996, (57) 167–175.
- [11] El-Hamid, A., Khair-El-Din, M., *Earth Sheltered Housing: An Approach to Energy Conservation in Hot Arid Areas*, *Architecture and Planning*, 1991, (3) 3-18.

- [12] Kumara, R., Sachdevab, S., Kaushik, S.C., Dynamic earth-contact building: A sustainable low-energy technology, *Building and Environment*, 2007, (42) 2450–2460.
- [13] Anselm, A.J., Passive annual heat storage principles in earth sheltered housing, a supplementary energy saving system in residential housing, *Energy and Buildings*, 2008, (40) 1214-1219.
- [14] Al-Neama, B.H.A., Energy Performance of Earth Sheltered Spaces in Hot-Arid Regions, MSc. Thesis, Faculty of Engineering & IT, The British University in Dubai, 2011.
- [15] van Dronkelaar, C., Underground buildings - Potential in terms of energy reduction, MSc. Thesis, Department of the Built Environment, Eindhoven University of Technology, 2013.
- [16] Mazarrón, F., López-Ocón, E., Garcimartín, M., Cañas, I., Assessment of basement constructions in the winery industry, *Tunnelling Underground Space Technology*, 2013, (35) 200-206.
- [17] Barbaresi, A., Torreggiani, D., Benni, S., Tassinari, P., Underground cellar thermal simulation: Definition of a method for modelling performance assessment based on experimental calibration, *Energy and Buildings*, 2014, (76) 363–372.
- [18] Mazarrón, F., Cañas, I., Seasonal analysis of the thermal behaviour of traditional underground winecellars in Spain, *Renewable Energy*, 2009, (34) 2484–2492.
- [19] (<http://en.wikipedia.org/wiki/Yazd>) (2013-12-8).
- [20] Judkoff, R., Neymark, J., International Energy Agency Building Energy Simulation Test and Diagnostic Method, national laboratory of U.S. department of energy, Colorado, 2009.
- [21] Mazarrón, F.R., Cid-Falceto, J., Canas, I., An assessment of using ground thermal inertia as passive thermal technique in the wine industry around the world, *Applied Thermal Engineering*, 2012, (33,34) 54–61.
- [22] Labs, K., Underground building climate, *Solar Age*, 1979, (4) 44-50.